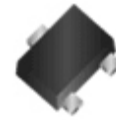
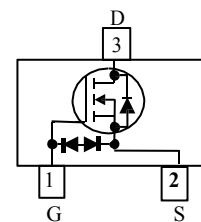

**WNM2077**
**Single N-Channel, 20V, 0.54A, Power MOSFET**
[Http://www.willsemi.com](http://www.willsemi.com)

V <sub>DS</sub> (V)	R <sub>ds(on)</sub> (Ω)
20	0.420@ V <sub>GS</sub> =4.5V
	0.580@ V <sub>GS</sub> =2.5V
	0.840@ V <sub>GS</sub> =1.8V
ESD Protected	

**SOT-723**
**Descriptions**

The WNM2077 is N-Channel enhancement MOS Field Effect Transistor. Uses advanced trench technology and design to provide excellent R<sub>DS(ON)</sub> with low gate charge. This device is suitable for use in DC-DC conversion, power switch and charging circuit. Standard Product WNM2077 is Pb-free.

**Pin configuration (Top view)**
**Features**

- Trench Technology
- Supper high density cell design
- Excellent ON resistance for higher DC current
- Extremely Low Threshold Voltage
- Small package SOT-723

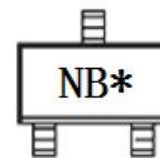

NB = Device Code  
\* = Month (A~Z)

**Marking**
**Applications**

- Driver for Relay, Solenoid, Motor, LED etc.
- DC-DC converter circuit
- Power Switch
- Load Switch
- Charging

**Order information**

Device	Package	Shipping
WNM2077-3/TR	SOT-723	8000/Reel&Tape

**Absolute Maximum ratings**

Parameter		Symbol	10 S	Steady State	Unit
Drain-Source Voltage		$V_{DS}$	20		V
Gate-Source Voltage		$V_{GS}$	$\pm 10$		
Continuous Drain Current <sup>ad</sup>	$T_A=25^\circ\text{C}$	$I_D$	0.54	0.51	A
	$T_A=70^\circ\text{C}$		0.43	0.41	
Maximum Power Dissipation <sup>ad</sup>	$T_A=25^\circ\text{C}$	$P_D$	0.36	0.31	W
	$T_A=70^\circ\text{C}$		0.23	0.20	
Continuous Drain Current <sup>bd</sup>	$T_A=25^\circ\text{C}$	$I_D$	0.49	0.44	A
	$T_A=70^\circ\text{C}$		0.39	0.35	
Maximum Power Dissipation <sup>bd</sup>	$T_A=25^\circ\text{C}$	$P_D$	0.29	0.23	W
	$T_A=70^\circ\text{C}$		0.18	0.14	
Pulsed Drain Current <sup>c</sup>		$I_{DM}$	0.9		A
Operating Junction Temperature		$T_J$	150		$^\circ\text{C}$
Lead Temperature		$T_L$	260		$^\circ\text{C}$
Storage Temperature Range		$T_{stg}$	-55 to 150		$^\circ\text{C}$

**Thermal resistance ratings**

Parameter		Symbol	Typical	Maximum	Unit
Junction-to-Ambient Thermal Resistance <sup>a</sup>	$t \leq 10 \text{ s}$	$R_{\theta JA}$	255	345	$^\circ\text{C/W}$
	Steady State		325	395	
Junction-to-Ambient Thermal Resistance <sup>b</sup>	$t \leq 10 \text{ s}$	$R_{\theta JA}$	375	430	
	Steady State		445	535	
Junction-to-Case Thermal Resistance		$R_{\theta JC}$	220	300	

a Surface mounted on FR-4 Board using 1 square inch pad size, 1oz copper

b Surface mounted on FR-4 board using minimum pad size, 1oz copper

c Pulse width < 380 $\mu\text{s}$ , Duty Cycle < 2%

d Maximum junction temperature  $T_J=150^\circ\text{C}$ .

**Electronics Characteristics (Ta=25°C, unless otherwise noted)**

Parameter	Symbol	Test Conditions	Min	Typ	Max	Unit
<b>OFF CHARACTERISTICS</b>						
Drain-to-Source Breakdown Voltage	$BV_{DSS}$	$V_{GS} = 0\text{ V}, I_D = 250\mu\text{A}$	20			V
Zero Gate Voltage Drain Current	$I_{DSS}$	$V_{DS} = 16\text{V}, V_{GS} = 0\text{V}$			1	$\mu\text{A}$
Gate-to-source Leakage Current	$I_{GSS}$	$V_{DS} = 0\text{ V}, V_{GS} = \pm 10\text{V}$			$\pm 5$	$\mu\text{A}$
<b>ON CHARACTERISTICS</b>						
Gate Threshold Voltage	$V_{GS(TH)}$	$V_{GS} = V_{DS}, I_D = 250\mu\text{A}$	0.45	0.70	1.0	V
Forward Transconductance	$g_{FS}$	$V_{DS} = 10\text{V}, I_D = 0.35\text{A}$		0.85		S
Drain-to-source On-resistance <sup>b, c</sup>	$R_{DS(on)}$	$V_{GS} = 4.5\text{V}, I_D = 0.35\text{A}$		420	600	m $\Omega$
		$V_{GS} = 3.1\text{V}, I_D = 0.20\text{A}$		500	700	
		$V_{GS} = 2.5\text{V}, I_D = 0.20\text{A}$		580	800	
		$V_{GS} = 1.8\text{V}, I_D = 0.20\text{A}$		840	1300	
		$V_{GS} = 1.5\text{V}, I_D = 0.04\text{A}$		1100	1600	
<b>CAPACITANCES, CHARGES</b>						
Input Capacitance	$C_{ISS}$	$V_{GS} = 0\text{ V},$ $f = 1\text{MHz},$ $V_{DS} = 10\text{ V}$		30		pF
Output Capacitance	$C_{OSS}$			7		
Reverse Transfer Capacitance	$C_{RSS}$			5		
Total Gate Charge	$Q_{G(TOT)}$	$V_{GS} = 4.5\text{ V},$ $V_{DS} = 10\text{ V},$ $I_D = 0.54\text{A}$		1.07		nC
Threshold Gate Charge	$Q_{G(TH)}$			0.12		
Gate-to-Source Charge	$Q_{GS}$			0.32		
Gate-to-Drain Charge	$Q_{GD}$			0.14		
<b>SWITCHING CHARACTERISTICS</b>						
Turn-On Delay Time	$t_d(ON)$	$V_{GS} = 4.5\text{ V},$ $V_{DD} = 10\text{ V},$ $I_D = 0.54\text{ A},$ $R_G = 6\ \Omega$		7.2		ns
Rise Time	$t_r$			9.5		
Turn-Off Delay Time	$t_d(OFF)$			19.6		
Fall Time	$t_f$			4.6		
<b>BODY DIODE CHARACTERISTICS</b>						
Forward Voltage	$V_{SD}$	$V_{GS} = 0\text{ V}, I_S = 0.3\text{A}$		0.85	1.5	V

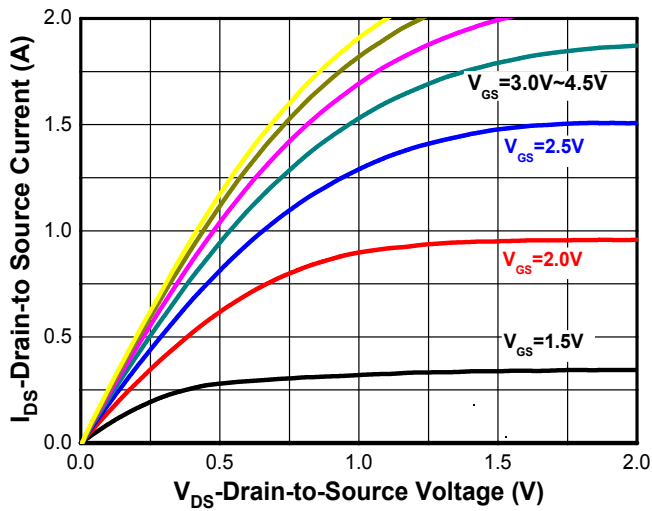
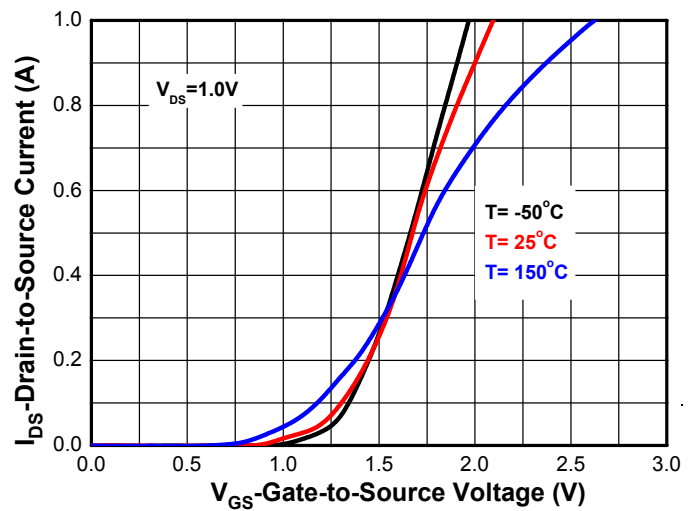
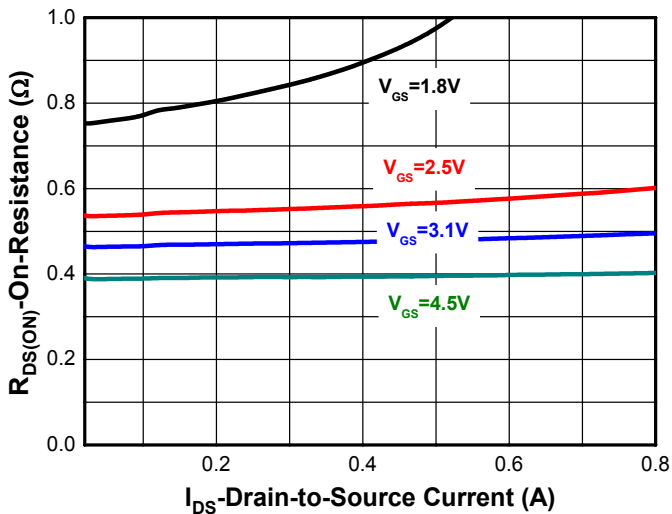
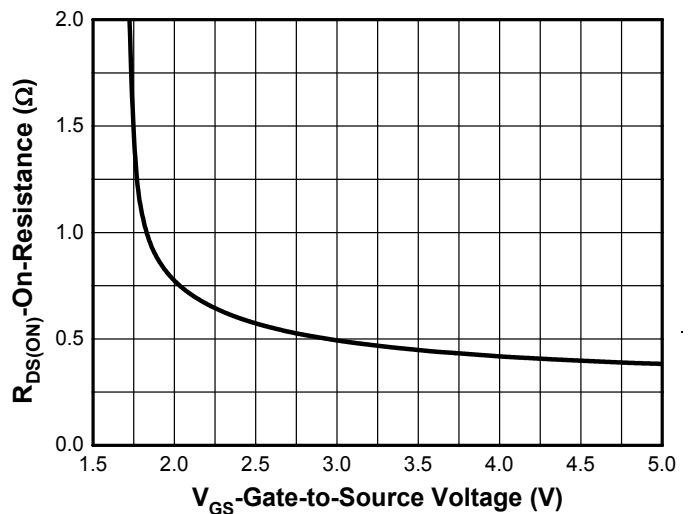
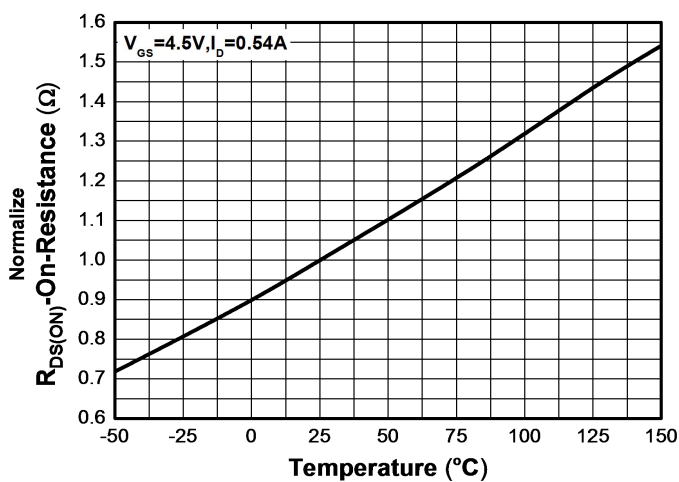
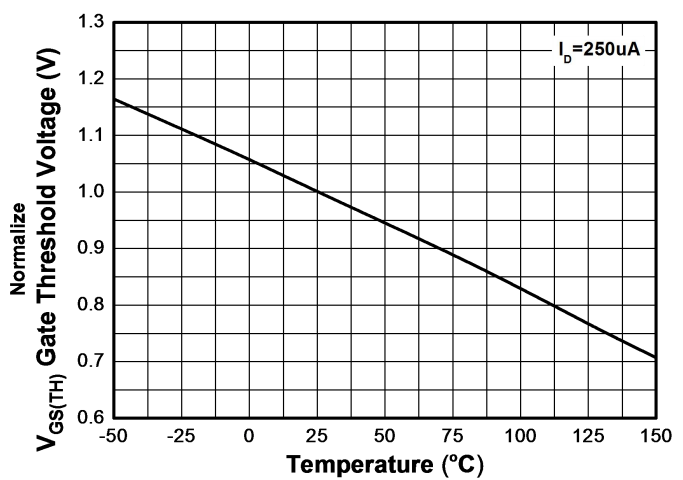
**Typical Characteristics (Ta=25°C, unless otherwise noted)**

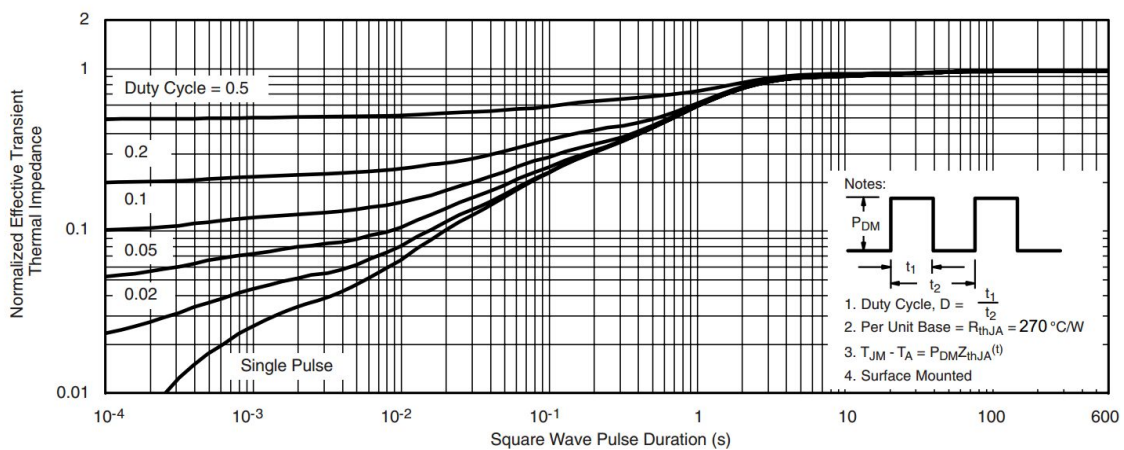
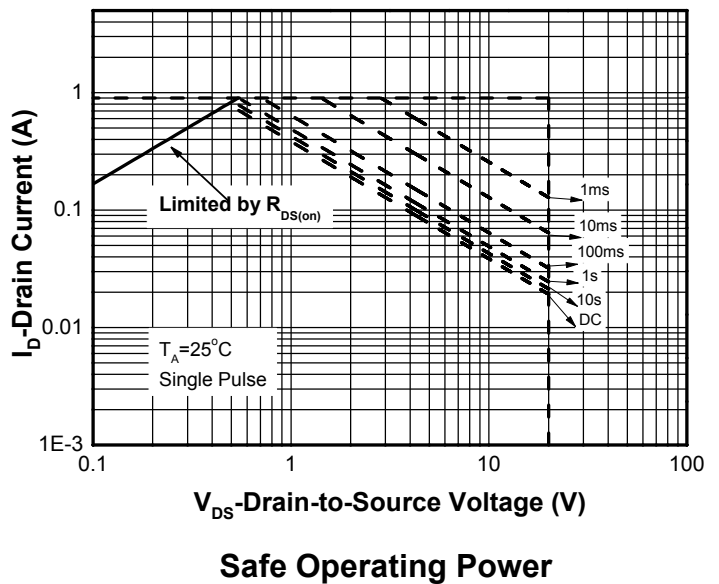
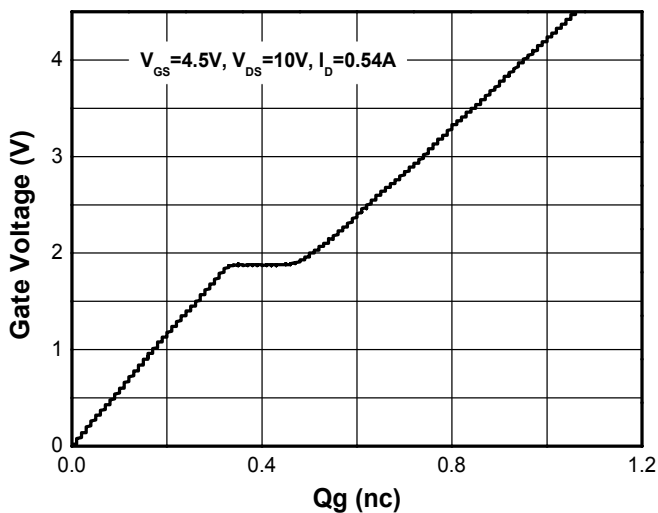
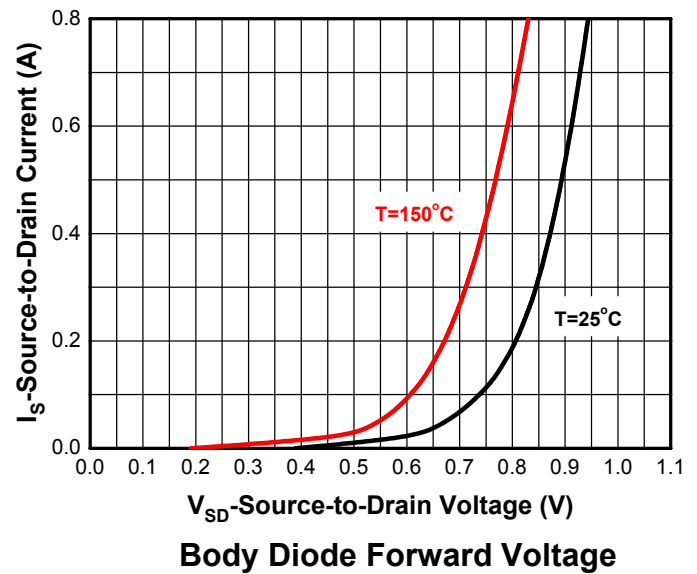
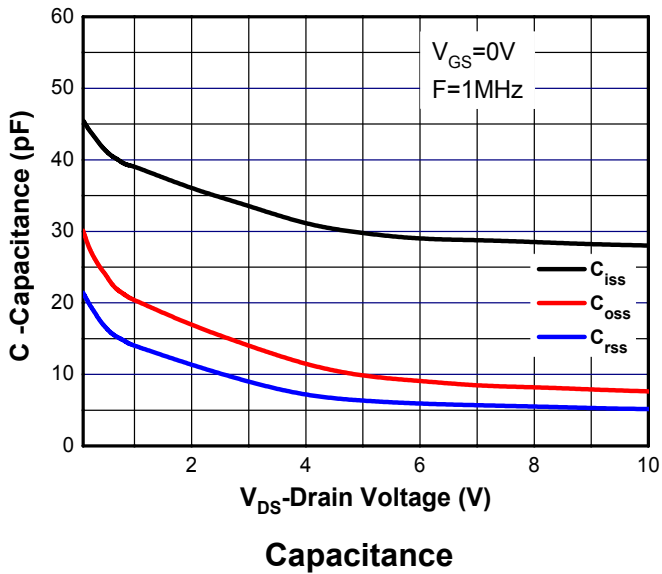
**Output Characteristics**

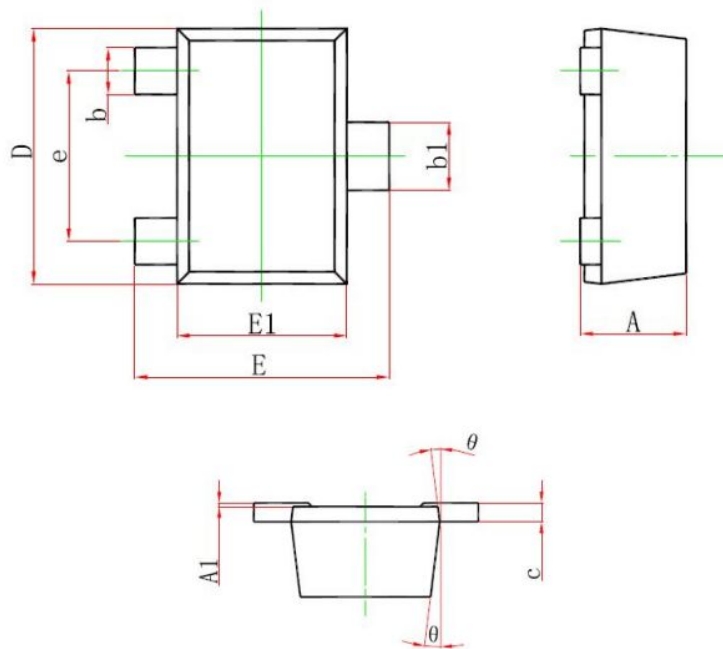
**Transfer Characteristics**

**On Resistance vs. Drain Current**

**On Resistance vs.  $V_{GS}$** 

**On Resistance vs. Junction Temperature**

**Threshold Voltage vs. Temperature**



**Package outline dimensions**
**SOT-723**

Symbol	Dimension in Millimeters	
	Min.	Max.
A		0.500
A1	0.000	0.050
b	0.170	0.270
b1	0.270	0.370
c		0.150
D	1.150	1.250
E	1.150	1.250
E1	0.750	0.850
e	0.800 TYP	
θ	7° REF.	