

WPM4803

P-Channel Enhancement Mode MOSFET

Description

The WPM4803 is the Dual P-Channel logic enhancement mode power field effect transistors are produced using high cell density , DMOS trench technology.

This high density process is especially tailored to minimize on-state resistance.

These devices are particularly suited for low voltage application , notebook computer power management and other battery powered circuits where high-side switching .

www.willsemi.com

PIN CONNECTIONS

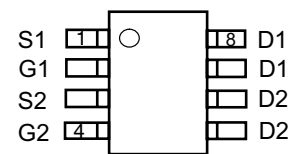

(Top View)

Features

- -30V/-5A, $R_{DS(ON)} = 36m\Omega @ V_{GS} = -10V$
- -30V/-4A, $R_{DS(ON)} = 53m\Omega @ V_{GS} = -4.5V$
- Super high density cell design for extremely low $R_{DS(ON)}$
- Exceptional on-resistance and maximum DC current capability
- SOP – 8P package design

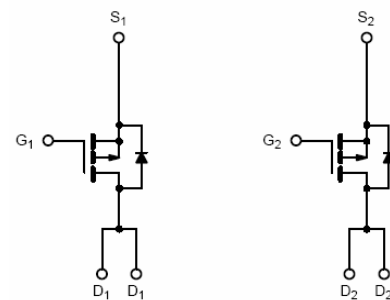

Application

- Power Management in Note book
- Portable Equipment
- Battery Powered System
- DC/DC Converter
- Load Switch
- DSC
- LCD Display inverter

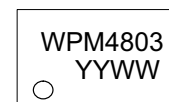

YYWW = Date Code
WPM4803 = Specific Device Code

Marking Diagram and explain

Order information

Part Number	Part Number	Shipping
WPM4803-8/TR	SOP-8P	2500Tape&Reel

Pin Assignment

Pin	Symbol	Description
1	S1	Source 1
2	G1	Gate 1
3	S2	Source 2
4	G2	Gate 2
5	D2	Drain 2
6	D2	Drain 2
7	D1	Drain 1
8	D1	Drain 1

Absolute Maximum Ratings

($T_A=25^{\circ}\text{C}$ Unless otherwise noted)

Parameter	Symbol	Typical	Unit
Drain-Source Voltage	V_{DSS}	-30	V
Gate –Source Voltage	V_{GSS}	± 20	V
Continuous Drain Current($T_J=150^{\circ}\text{C}$)	I_D	$T_A=25^{\circ}\text{C}$	-5.5
		$T_A=70^{\circ}\text{C}$	-4.4
Pulsed Drain Current	I_{DM}	-20	A
Continuous Source Current(Diode Conduction)	I_S	-2.3	A
Power Dissipation	P_D	$T_A=25^{\circ}\text{C}$	2.0
		$T_A=70^{\circ}\text{C}$	1.2
Operating Junction Temperature	T_J	-55/150	$^{\circ}\text{C}$
Storage Temperature Range	T_{STG}	-55/150	$^{\circ}\text{C}$
Thermal Resistance-Junction to Ambient	$R_{\theta JA}$	62.5	$^{\circ}\text{C}/\text{W}$

Typical Performance Characteristics

(TA=25°C Unless otherwise noted)

Parameter	Symbol	Conditions	Min.	Typ	Max.	Unit
Static						
Drain-Source Breakdown Voltage	V _{(BR)DSS}	V _{GS} =0V, I _D =-250uA	-30			V
Gate Threshold Voltage	V _{GS(th)}	V _{DS} =V _{GS} , I _D =-250uA	-1.0	-1.9	-3.0	
Gate Leakage Current	I _{GSS}	V _{DS} =0V, V _{GS} =±20V			±100	nA
Zero Gate Voltage Drain Current	I _{DSS}	V _{DS} =-24V, V _{GS} =0V			-1	uA
		V _{DS} =-24V, V _{GS} =0V T _J =85°C			-5	
On-State Drain Current	I _{D(on)}	V _{DS} = -5V, V _{GS} =-10V	-20			A
Drain-Source On-Resistance	R _{DS(on)}	V _{GS} =-10V, I _D =-5.0A		0.036	0.046	Ω
		V _{GS} =-4.5V, I _D =-4.0A		0.053	0.066	
Forward Transconductance	g _{fs}	V _{DS} =-5V, I _D =-5.0A	5	8		S
Diode Forward Voltage	V _{SD}	I _S =-1.0A, V _{GS} =0V	-0.5	-0.79	-1.5	V

Dynamic

Total Gate Charge	Q _g	V _{DS} =-15V, V _{GS} =-10V I _D = -5.0A		15	25	nC
Gate-Source Charge	Q _{gs}			2		
Gate-Drain Charge	Q _{gd}			3.8		
Input Capacitance	C _{iss}	V _{DS} =-15V, V _{GS} =0V f=1MHz		680		pF
Output Capacitance	C _{oss}			120		
Reverse Transfer Capacitance	C _{rss}			75		
Turn-On Time	t _{d(on)}	V _{DD} =-15V, R _L =15Ω I _D =-1.0A, V _{GEN} =-10V R _G =6Ω		7	15	nS
	t _r			10	20	
Turn-Off Time	t _{d(off)}			40	80	
	t _f			20	40	

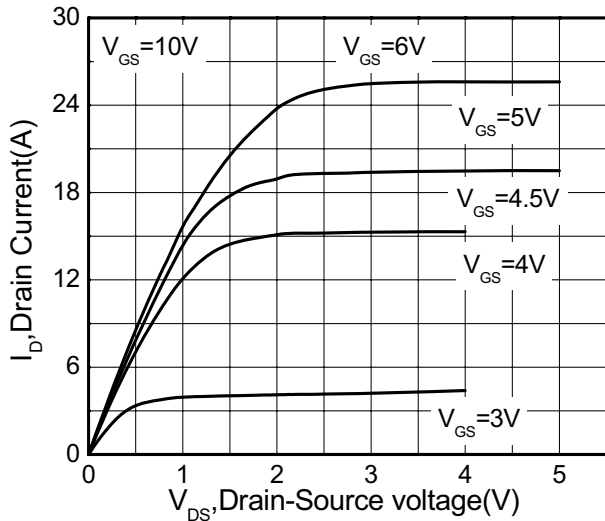
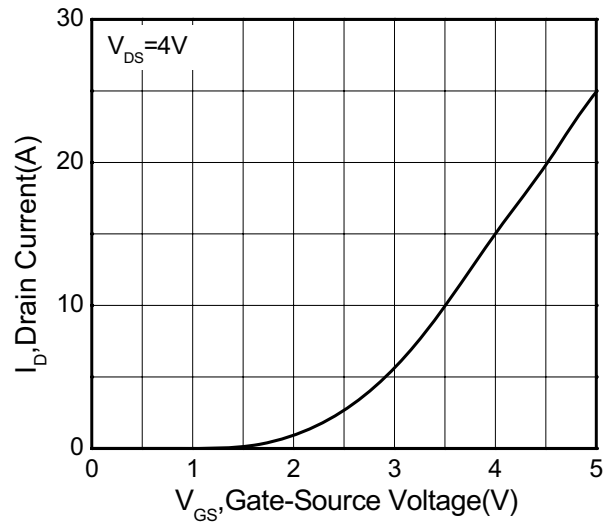
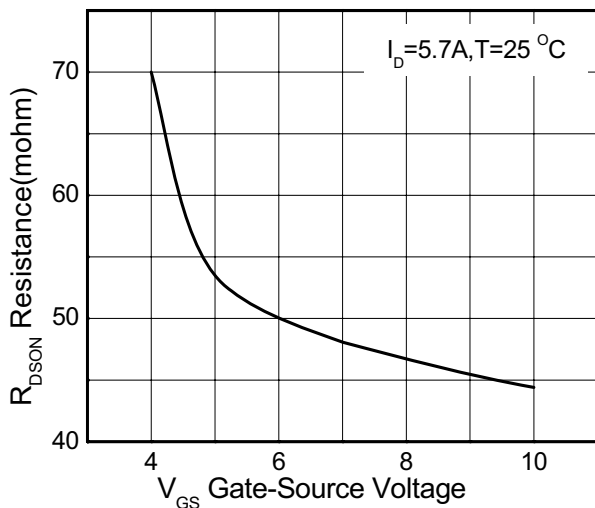
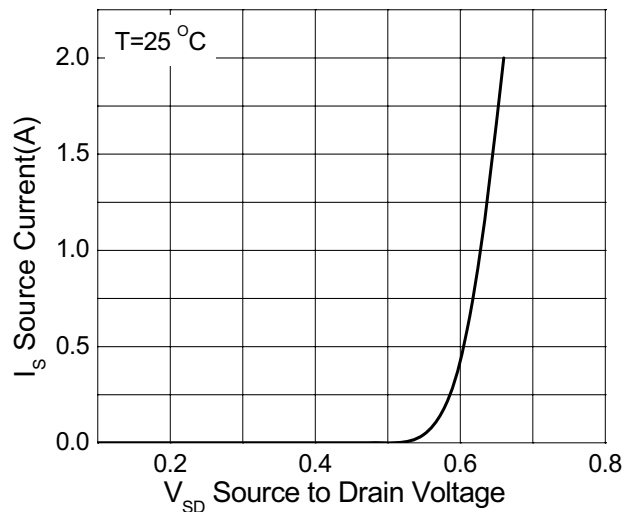
Typical Characteristics

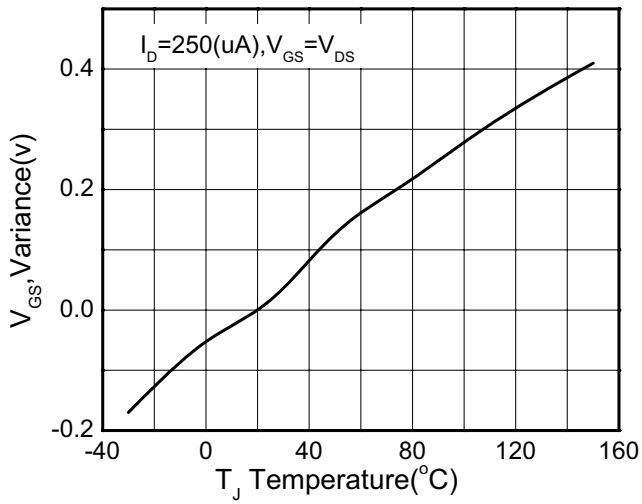
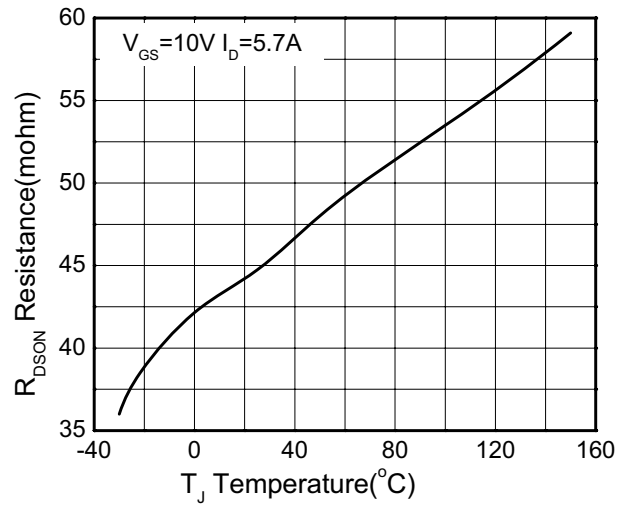
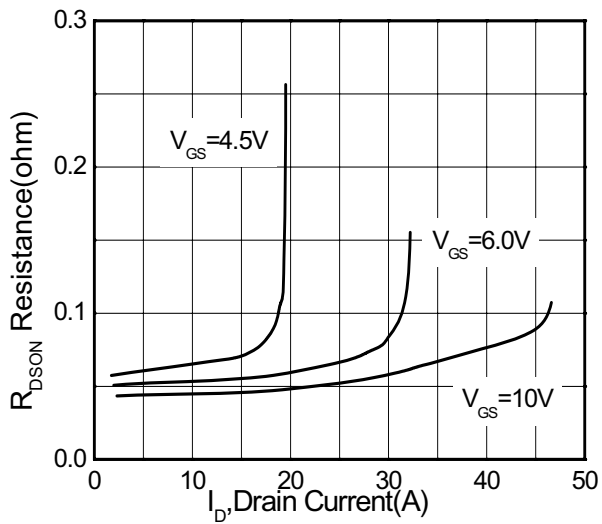
Drain Current VS Drain-Source voltage

Drain Current VS Gate-Source Voltage

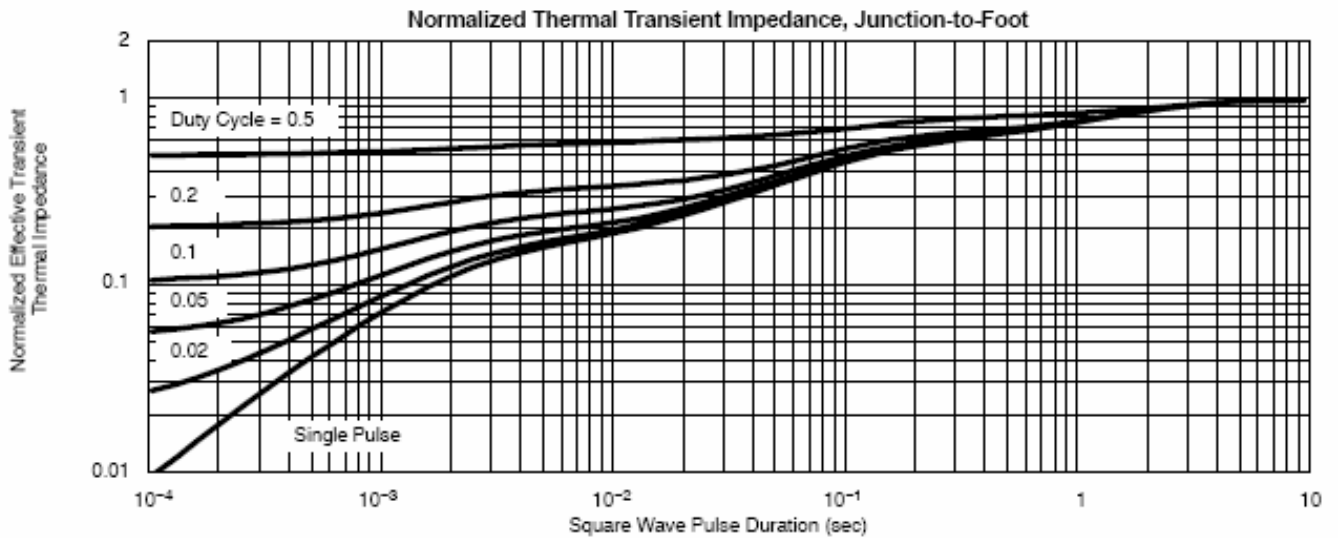
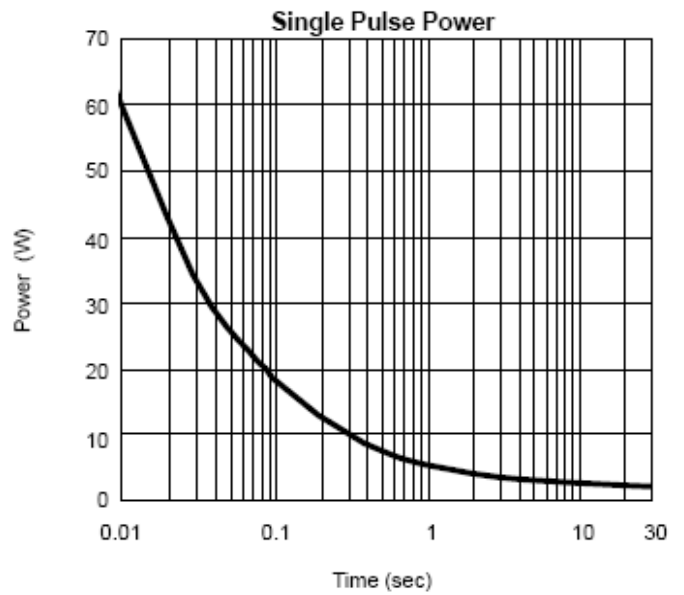
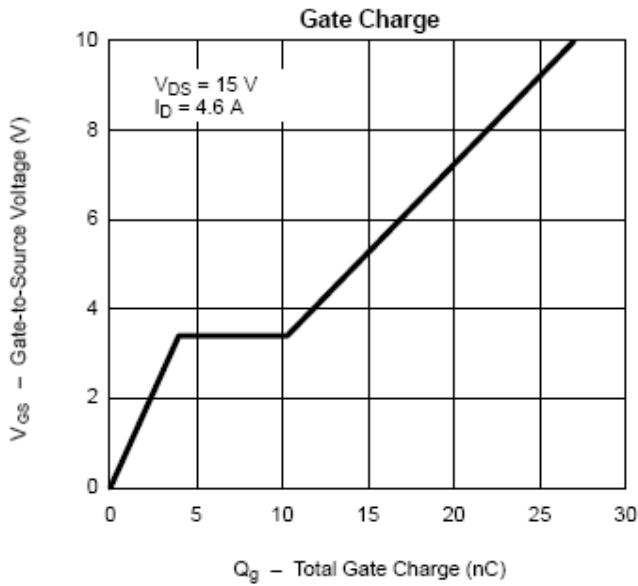
 R_{DSON} Resistance VS Gate-Source Voltage

Source Current VS Source to Drain Voltage

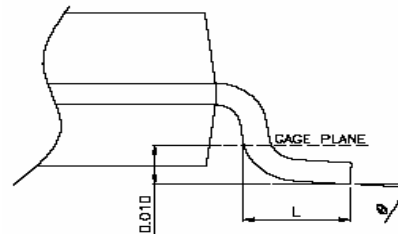
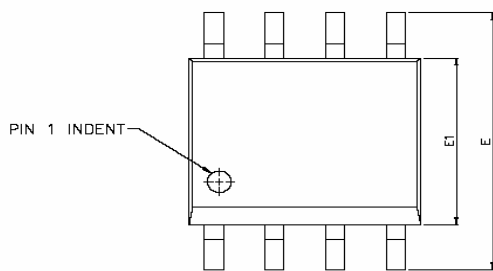
Typical Characteristics

 V_{GS} , Variance vs Temperature

 $R_{DS(on)}$ Resistance VS T_J Temperature

 $R_{DS(on)}$ Resistance VS I_D , Drain Current

Typical Characteristics



Packaging Information



DETAIL A

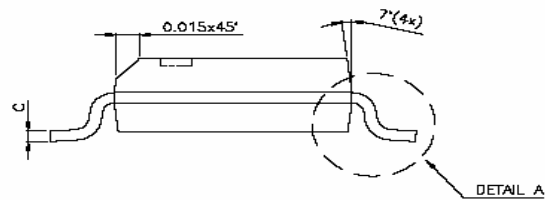
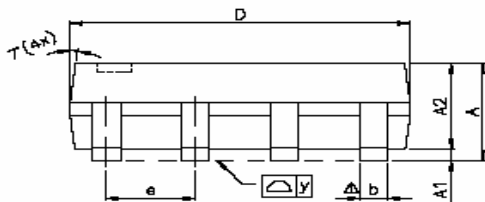

SYMBOLS	DIMENSIONS IN MILLIMETERS			DIMENSIONS IN INCHES		
	MIN	NOM	MAX	MIN	NOM	MAX
A	1.47	1.60	1.73	0.058	0.063	0.068
A1	0.10	—	0.25	0.004	—	0.010
A2	—	1.45	—	—	0.057	—
b	0.33	0.41	0.51	0.013	0.016	0.020
C	0.19	0.20	0.25	0.0075	0.008	0.0098
D	4.80	4.85	4.95	0.189	0.191	0.195
E	5.80	6.00	6.20	0.228	0.236	0.244
E1	3.80	3.90	4.00	0.150	0.154	0.157
e	—	1.27	—	—	0.050	—
L	0.38	0.71	1.27	0.015	0.028	0.050
Δ y	—	—	0.076	—	—	0.003
\varnothing	0°	—	8°	0°	—	8°