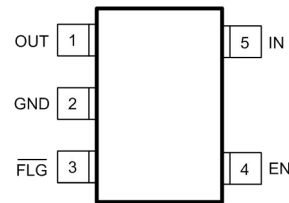

WS4611
80mΩ, Current Limited, Power Distribution Switch
www.sh-willsemi.com
Descriptions

The WS4611 is high-side switch with ultra-low ON resistance P-MOSFET. Integrated current-limit function can limit inrush current for heavy capacitive load, over load current, and short-circuit current to protect power source.

The WS4611 is also integrated reverse protection function to eliminate any reverse current flow across the switch when the device is off. Thermal shutdown function can protect the device and load. The output auto-discharge function is disabled in WS4611.

The WS4611 is available in SOT-23-5L package. Standard product is Pb-free and Halogen-free.

SOT-23-5L

Pin configuration (Top view)
Features

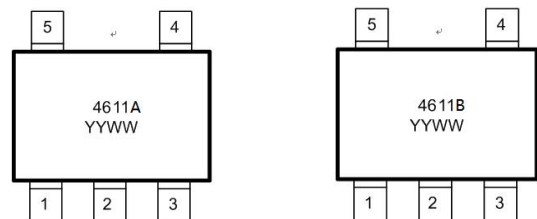
- Input voltage range : 2.5~5.5
- Main switch R_{ON} : 80mΩ @ $V_{IN}=5V$
- Current limit threshold
 - WS4611A : 1.5A (Typ.)
 - WS4611B : 1.0A (Typ.)
- Current limit accuracy
 - WS4611A : +/- 20%
 - WS4611B : +/- 30%
- Reverse block (No "body diode")
- Over temperature protection



4611A/4611B = Device code
YY = Year code
WW = Week code

Marking
Applications

- USB peripherals
- USB Dongle
- USB 3G data card
- 3.3V or 5V Power Switch
- 3.3V or 5V Power Distribution

Order information

Device	Package	Shipping
WS4611EA-5/TR	SOT-23-5L	3000/Reel&Tape
WS4611EB-5/TR	SOT-23-5L	3000/Reel&Tape

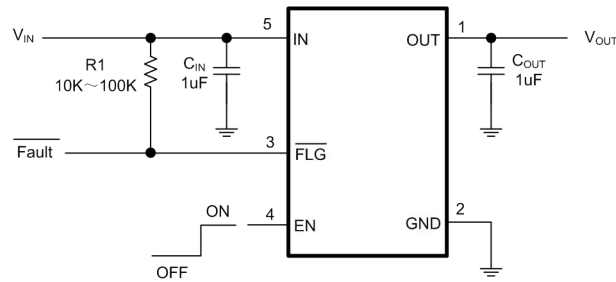
Typical Applications

Pin Descriptions

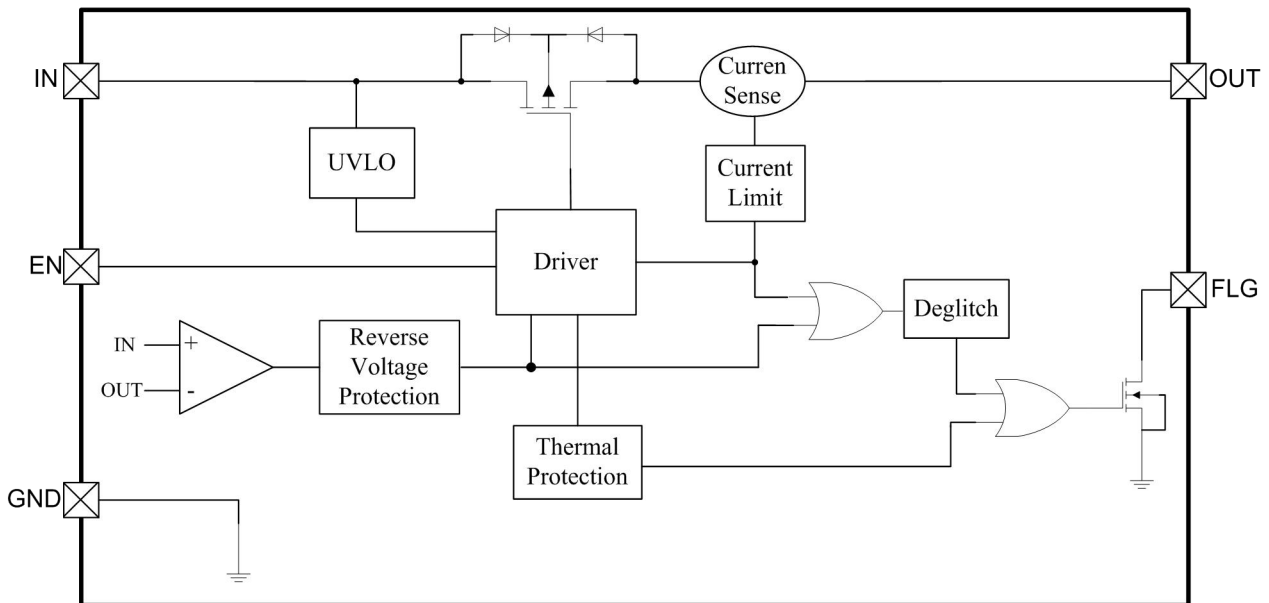
Pin Number	Symbol	Descriptions
1	OUT	Output Pin
2	GND	Ground
3	FLG	Fault Flag Pin, Open-Drain, Active Low
4	EN	Enable Pin, Active High
5	IN	Input Pin

Block Diagram

Absolute maximum ratings

Parameter	Symbol	Value	Unit
IN pin voltage range	V_{IN}	-0.3~6.5	V
OUT pin voltage range	V_{OUT}	-0.3~6.5	V
FLG pin voltage range	V_{FLG}	-0.3~6.5	V
EN pin voltage range	V_{EN}	-0.3~6.5	V
Junction temperature	T_J	-40~150	°C
Lead temperature(Soldering, 10s)	T_L	260	°C
Storage temperature	T_{stg}	-55 ~ 150	°C
IN, OUT Pin ESD Ratings	HBM	8000	V
	MM	400	V
FLG, EN Pin ESD Ratings	HBM	4000	V
	MM	400	V

These are stress ratings only. Stresses exceeding the range specified under “Absolute Maximum Ratings” may cause substantial damage to the device. Functional operation of this device at other conditions beyond those listed in the specification is not implied and prolonged exposure to extreme conditions may affect device reliability.

Recommend Operating Conditions

Parameter	Symbol	Value	Unit
Supply input voltage range	V_{IN}	2.5~5.5	V
Operating ambient temperature	T_A	-40~85	°C
Thermal Resistance	$R_{\theta JA}$	250	°C/W

Electronics Characteristics (Ta=25°C, V_{IN}=5V, C_{IN}=C_{OUT}=1uF, unless otherwise noted)

Parameter	Symbol	Conditions	Min.	Typ.	Max.	Units	
Quiescent supply current	I _Q	I _{OUT} =0, V _{IN} =V _{EN} =5V		48	60	uA	
Shutdown current	I _{SD}	V _{EN} =0V			1	uA	
Reverse current	I _{REV}	V _{IN} =V _{EN} =0V, V _{OUT} =5V, Current flow to V _{IN}			1	uA	
Main-FET ON resistance ⁽¹⁾	R _{ON}	V _{IN} =V _{EN} =5V, I _{OUT} =500mA		80		mΩ	
Auto-discharge FET ON resistance	R _{DCHG}	V _{EN} =0V, V _{IN} =V _{OUT} =5V		65		Ω	
Over-current trip threshold	I _{OC}	Current ramp (≤100A/s) on OUT	WS4611A	1.2	1.5	1.8	A
			WS4611B	0.7	1	1.4	A
Short-circuit output current	I _{OS}	OUT shorted to GND	WS4611A		0.7		A
			WS4611B		0.45		A
Short circuit current limiting response time	t _{SHORT}	OUT connected to GND, C _L =1uF		3		us	
EN input low voltage	V _{IL}	V _{IN} =5V			0.4	V	
EN input high voltage	V _{IH}	V _{IN} =5V	1.6			V	
OUT pin turn-on time after EN ON	t _{ON}	C _L =1uF, R _L =5ohm		20		us	
Fault flag output blanking time	t _{BLANK}			8		ms	
Over-temperature shutdown threshold	T _{SD}			160		°C	
Over-temperature threshold hysteresis	T _{HYS}			35		°C	
Under voltage lock out threshold	V _{UVLO}			2.2		V	
Under voltage lock out hysteresis	V _{UVLO-HYS}			200		mV	

Note: (1) Pulse test, T_P=380us

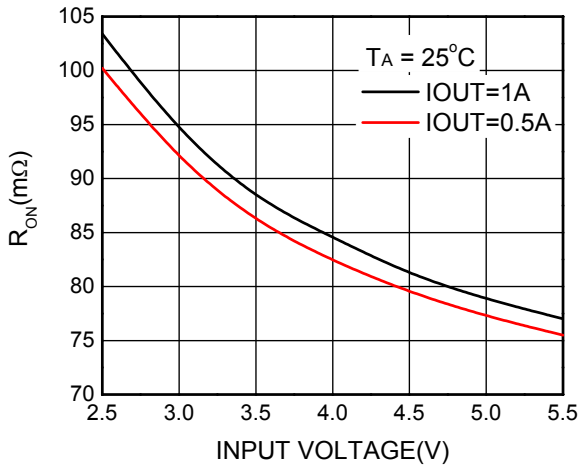
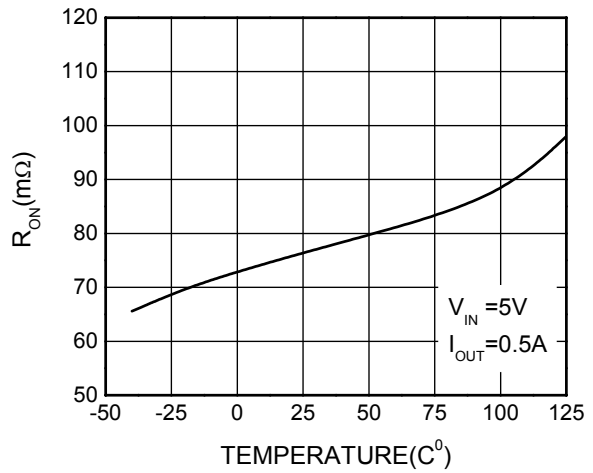
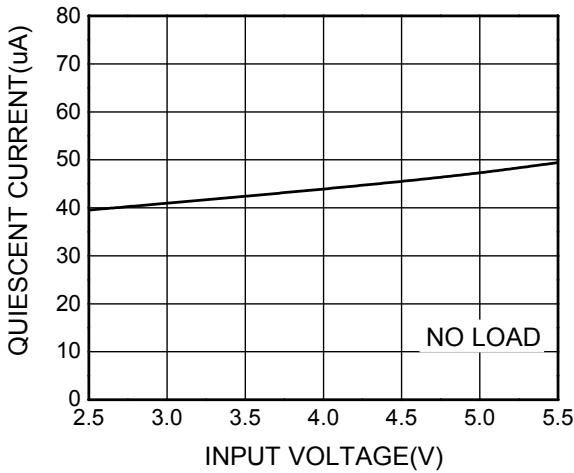
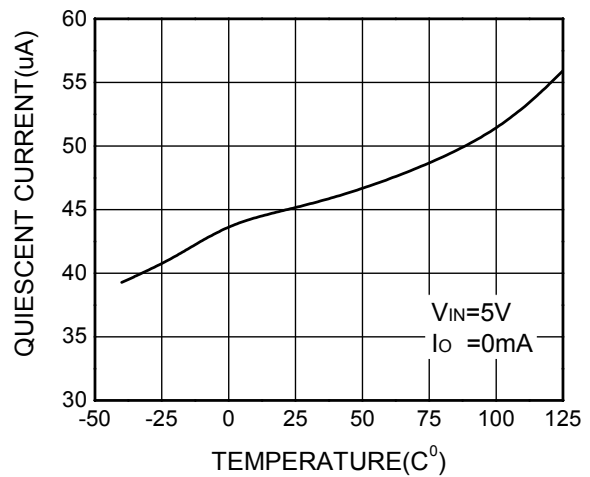
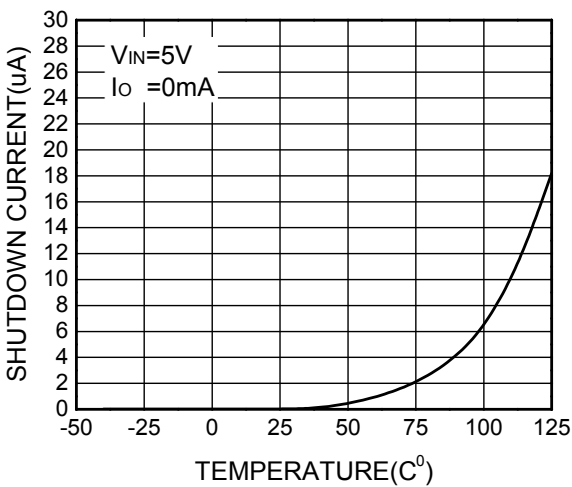
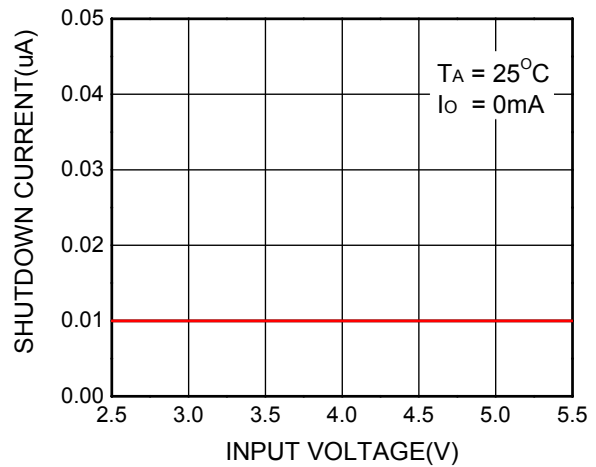
Typical Characteristics (Ta=25°C, unless otherwise noted)

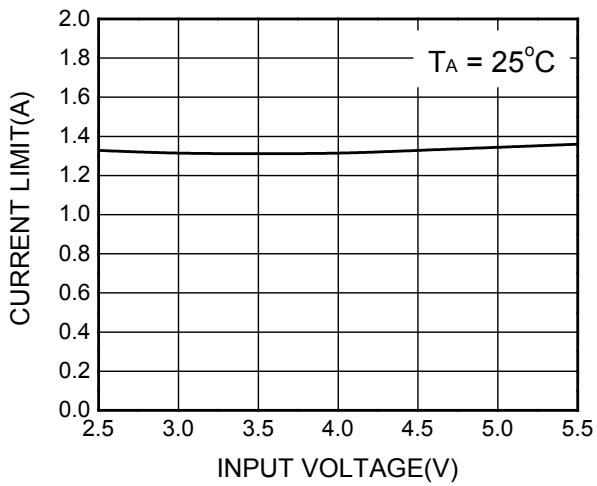
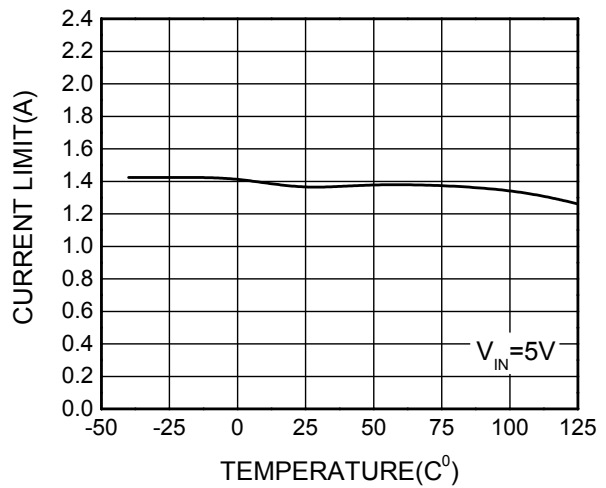
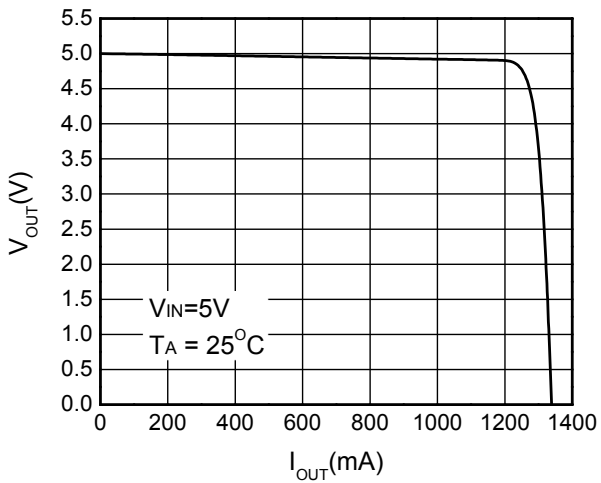
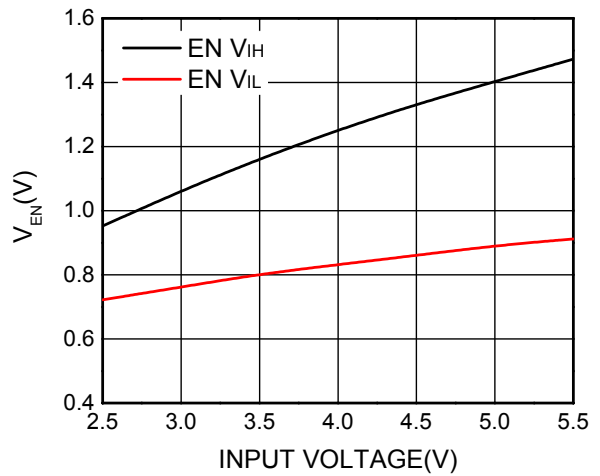
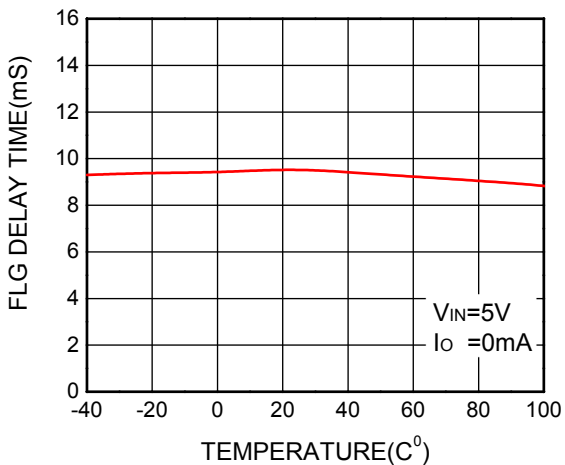
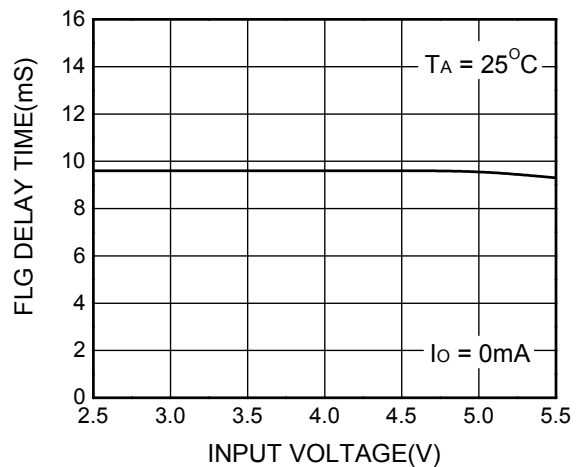
ON Resistance vs. Input Voltage

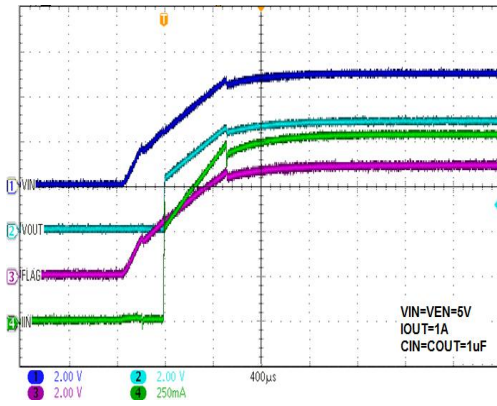
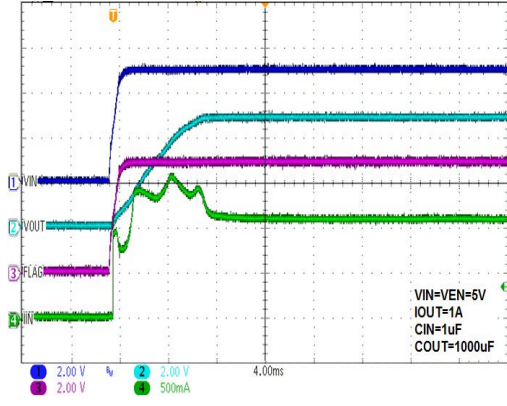
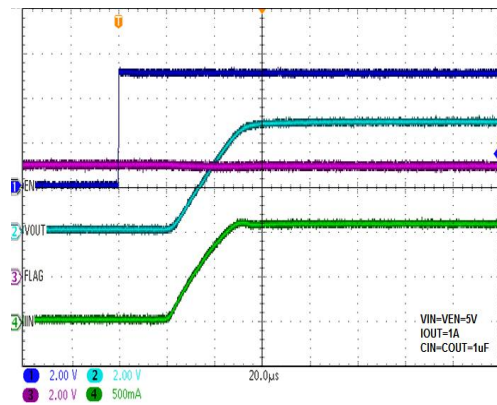
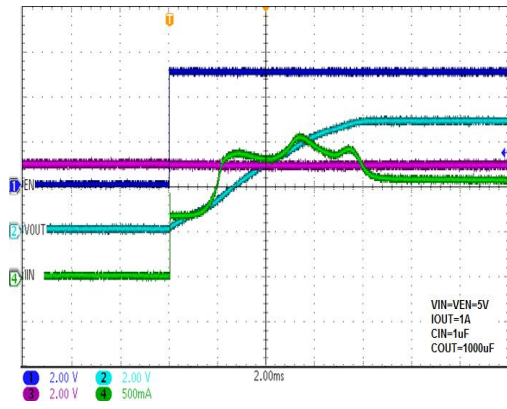
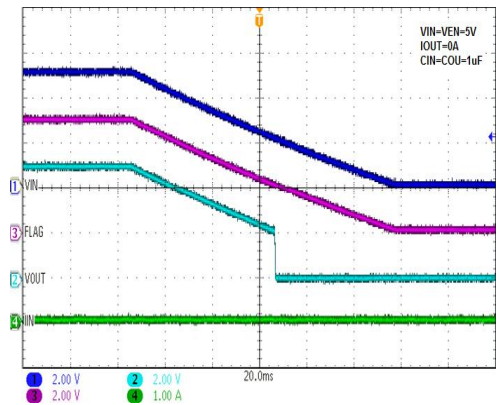
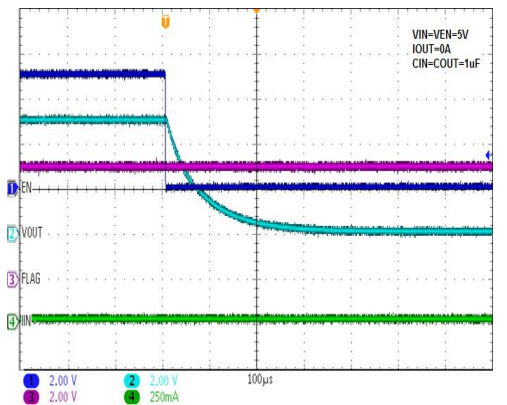
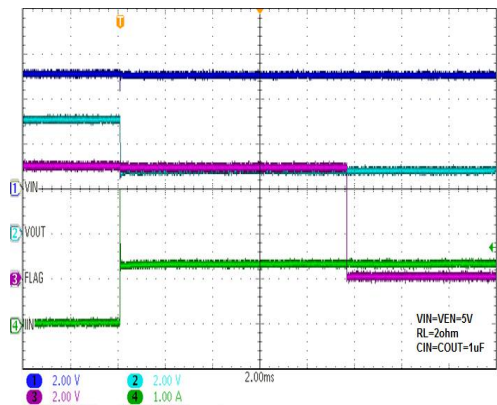
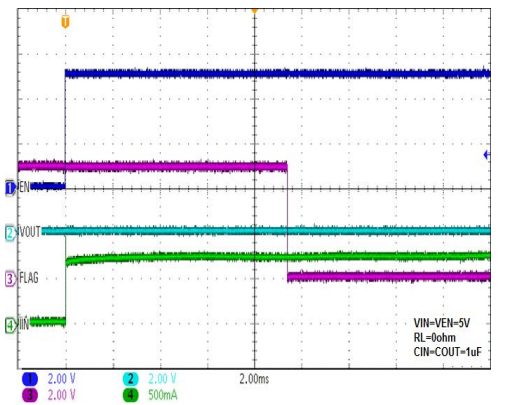
ON Resistance vs. Temperature

Quiescent current vs. Input Voltage

Quiescent current vs. Temperature

Shut-down Current vs. Temperature

Shut-down Current vs. Input Voltage

Current Limit vs. Input Voltage (WS4611A)

Current Limit vs. Temperature (WS4611A)

Output Voltage vs. Output Current (WS4611A)

EN Threshold vs. Input Voltage

Fault Flag Blanking time vs. Temperature

Fault Flag Blanking time vs. Temperature

Startup from Power ON (WS4611A)

Startup from Power ON (WS4611A)

Startup from Enable ON (WS4611A)

Startup from Enable ON (WS4611A)

Shutdown from Power OFF (WS4611A)

Shutdown from Enable OFF (WS4611A)

Current Limit Response (WS4611A)

Start into Short Circuit (WS4611A)

Operation Information

Power Switch

The power switch is an P-channel MOSFET with low $R_{DS(ON)}$ for power management or USB power distribution applications. The WS4611 has reverse voltage protection to prevents current flow from OUT to IN and IN to OUT when device is off.

Current-Limit Protection

The WS4611 provide current limit protection function to protect power source when over-current condition occurs.

Short-Circuit Protection

The WS4611 provide short circuit protection function. The output current will be limited to safe level. The short-circuit protection is used to reduce power dissipation of the device and protect power source during short-circuit condition.

Fault indicate

The \overline{FLG} open drain output is asserted (active low) with 8ms(Typ.) delay when an over-current or over-temperature condition is encountered. The \overline{FLG} signal will remain asserted until the over-current or over-temperature condition is removed.

UVLO Protection

To avoid malfunction of the WS4611 at low input voltages, an under voltage lockout is included that disables the device, until the input voltage exceeds 2.2V (Typ.).

Shutdown Mode

Drive EN to GND to place the WS4611 in shutdown mode. In shutdown mode, input current falls to smaller than 1 μ A.

Thermal Shutdown

As soon as the junction temperature (T_J) exceeds 160°C (Typ.), the WS4611 goes into thermal shutdown. In this mode, the device is turned off and will turn on again until Junction temperature falls below 125°C (Typ.).

Application Information

Input Capacitor

A 1uF input bypass ceramic capacitor(C_{IN}) from IN to GND, located near the WS4611 is strongly recommended to suppress the voltage overshooting during short circuit fault event. Without the bypass capacitor, the output short may cause sufficient ringing on the input (from supply lead inductance) to damage the device.

Output Capacitor

A low ESR, 150uF aluminum electrolytic or tantalum between OUT and GND is strongly recommended to reduce the voltage droop during hot-plug of downstream peripheral. Higher value output capacitor is better when the output load is heavy. Additionally, bypassing the output with a 1uF ceramic capacitor improves the immunity of the device to short-circuit transients.

PCB Layout consideration

The PCB layout should be carefully performed to maximize thermal dissipation and to minimize voltage drop. The following guidelines must be considered:

1. Please place the input capacitors near the IN pin as close as possible.
2. Output decoupling capacitors for load must be placed near the load as close as possible for decoupling high frequency ripples.
3. Locate WS4611 and output capacitors near the load to reduce parasitic resistance and inductance for excellent load transient performance.
4. The negative pins of the input and output capacitors and the GND pin must be connected to the ground plane of the load.
5. Keep IN and OUT traces as wide and short as possible.

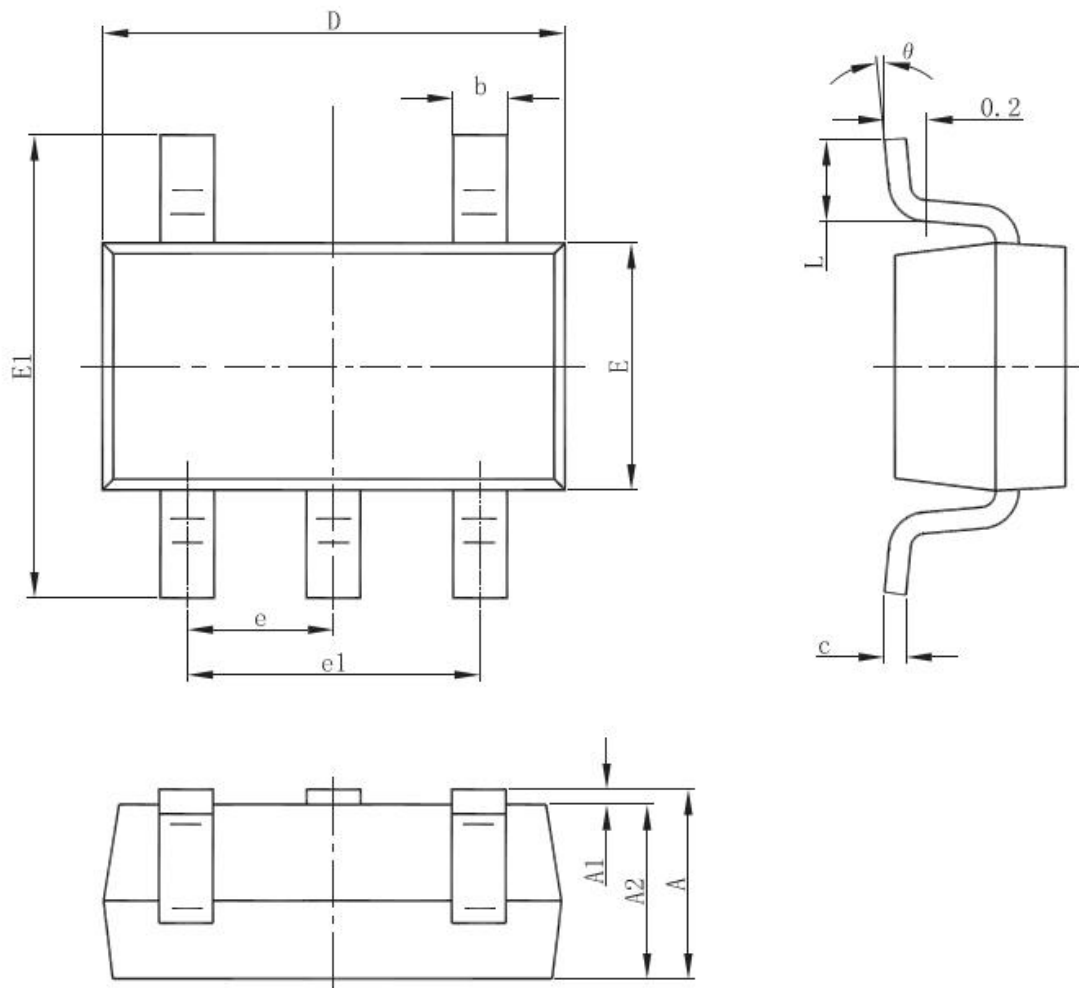
Package outline dimensions
SOT-23-5L

Symbol	Dimensions in millimeter		
	Min.	Typ.	Max.
A	1.050	-	1.250
A1	0.000	-	0.100
A2	1.050	-	1.150
b	0.300	-	0.500
c	0.100	-	0.200
D	2.820	2.900	3.020
E	1.500	1.600	1.700
E1	2.650	2.800	2.950
e	0.950(BSC)		
e1	1.800	-	2.000
L	0.300	-	0.600
theta	0°	-	8°